

A a

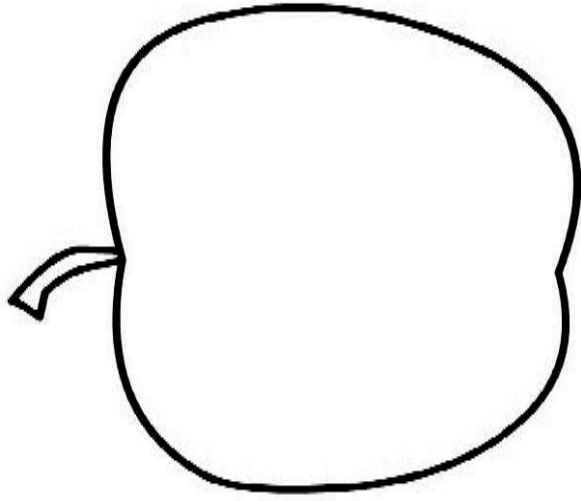

B b

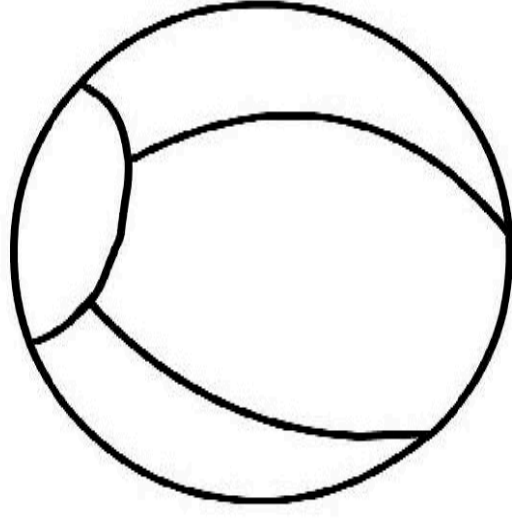

C C

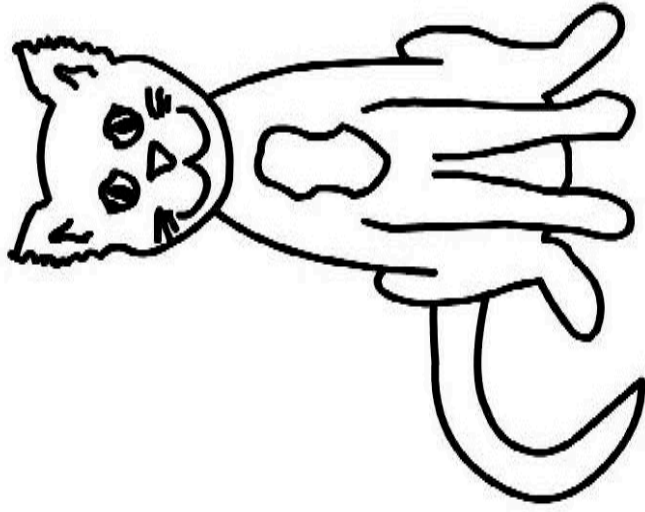

D d

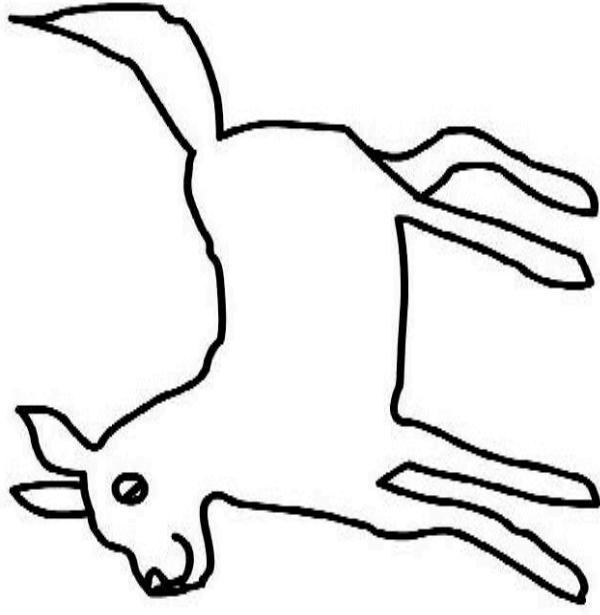

F

f

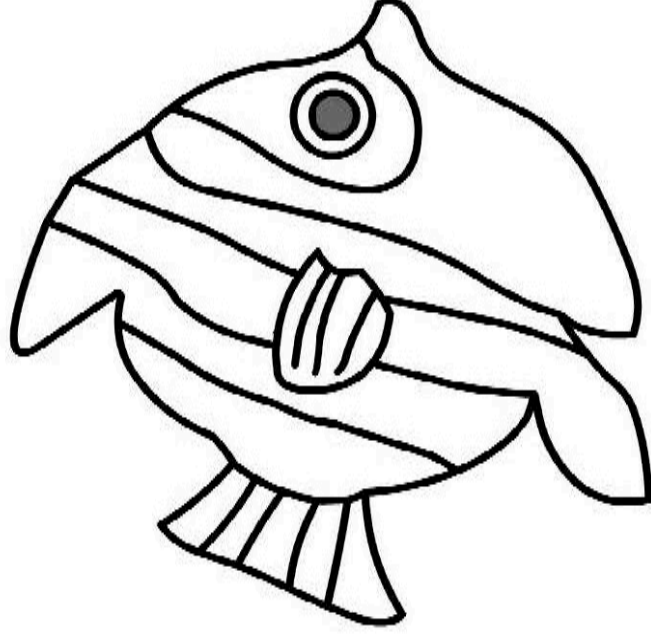

E

e

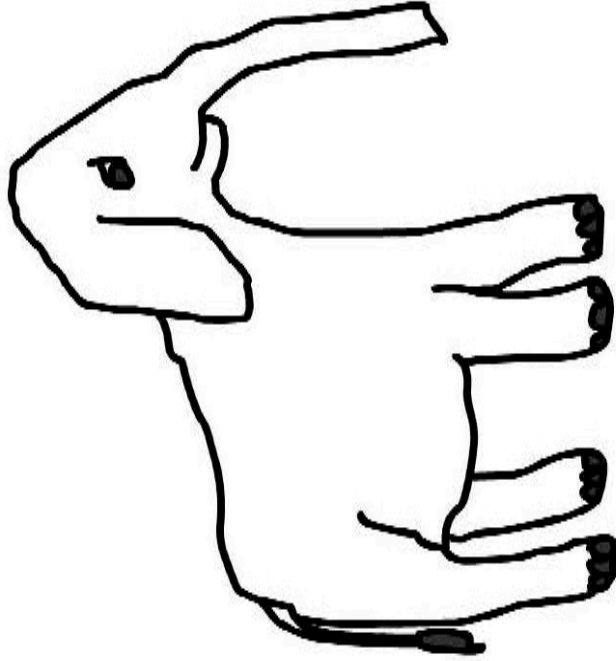

G g

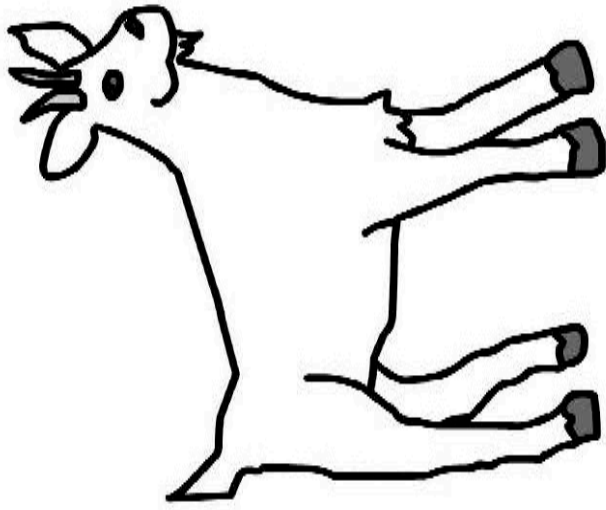

H h

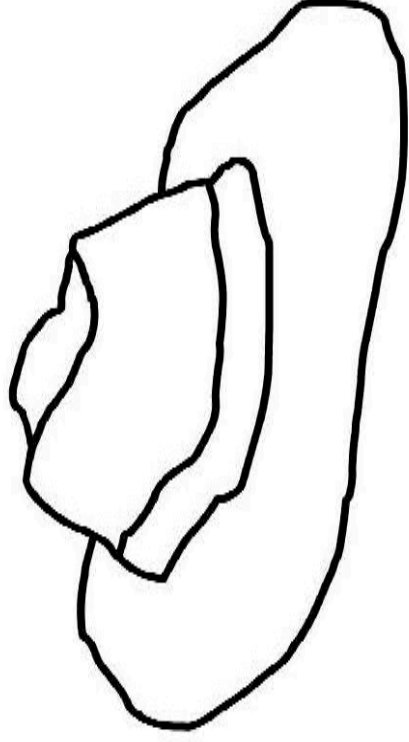

I

i

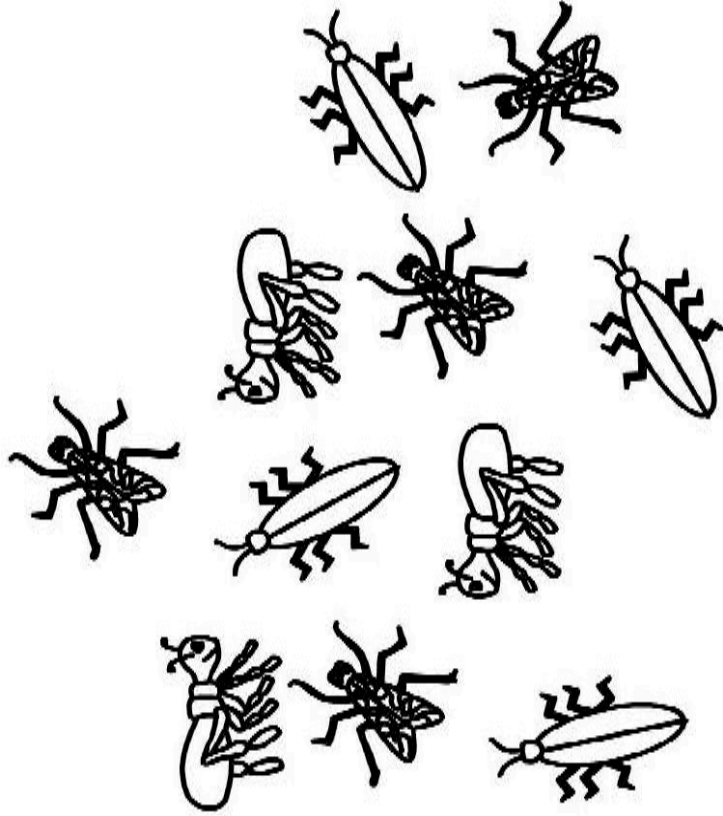

J

j

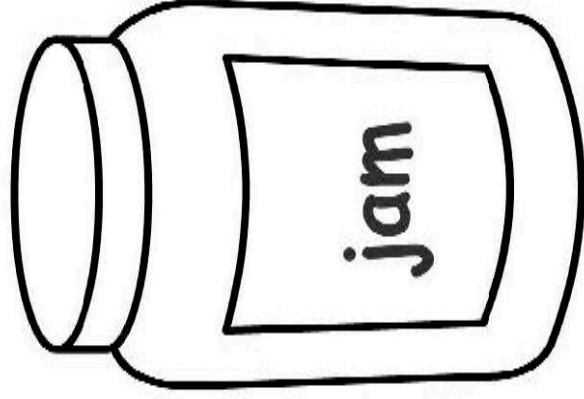

K k

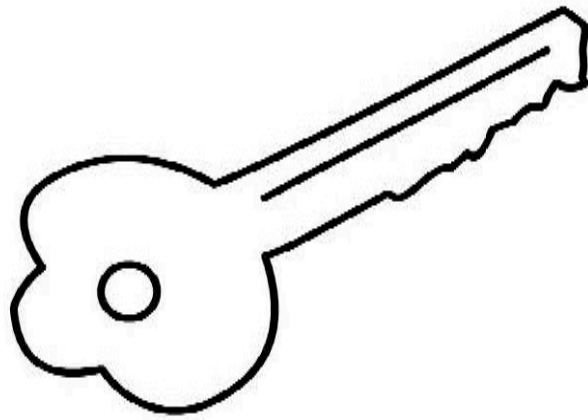

L l

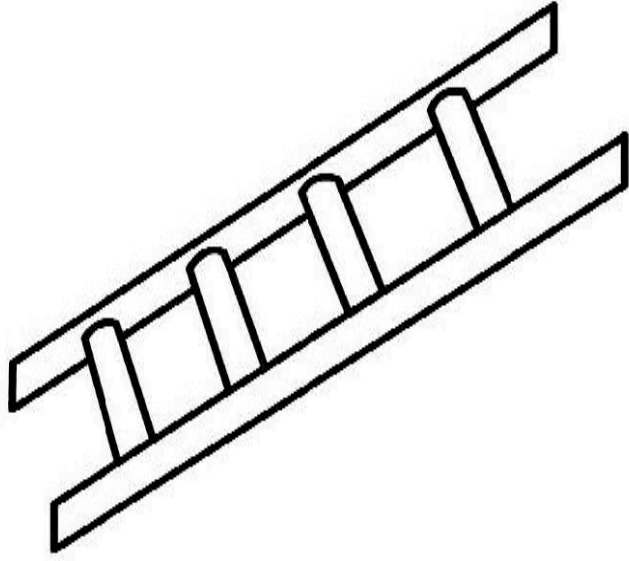

M m

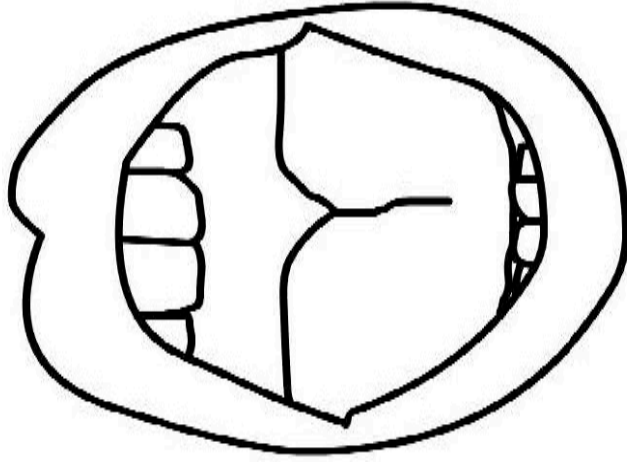

N n

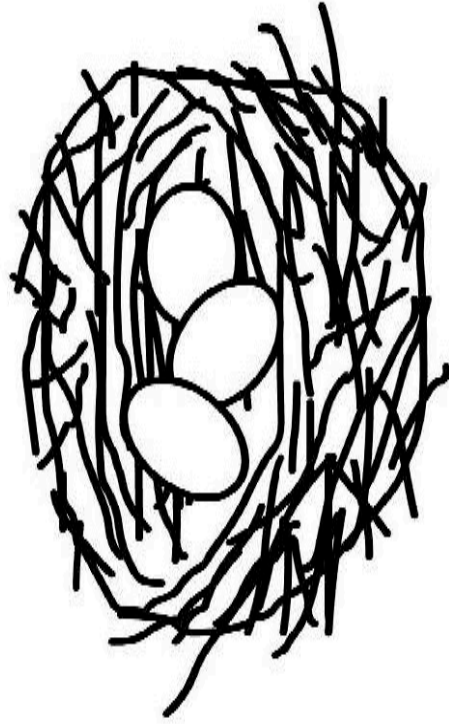

O O

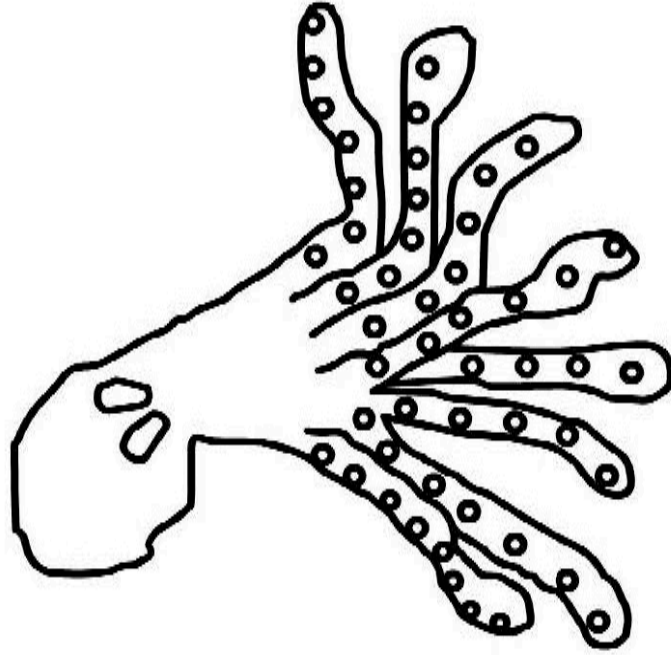

P

p

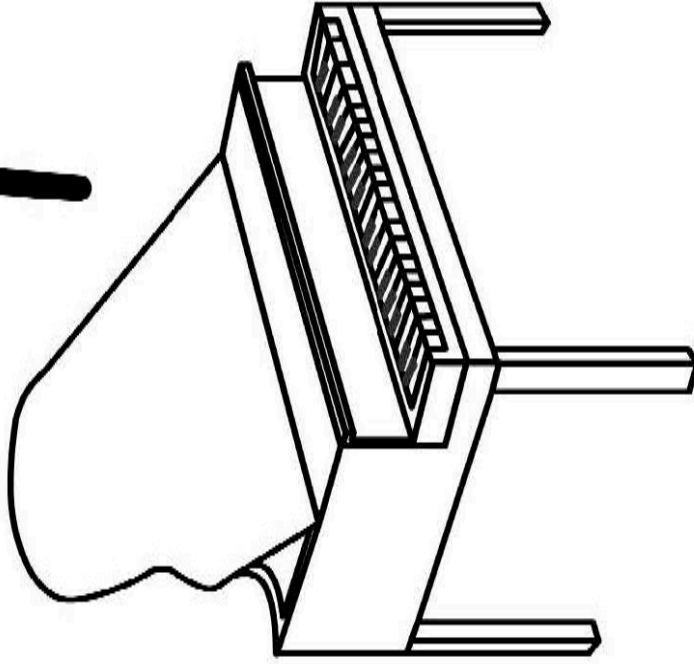



Q

q

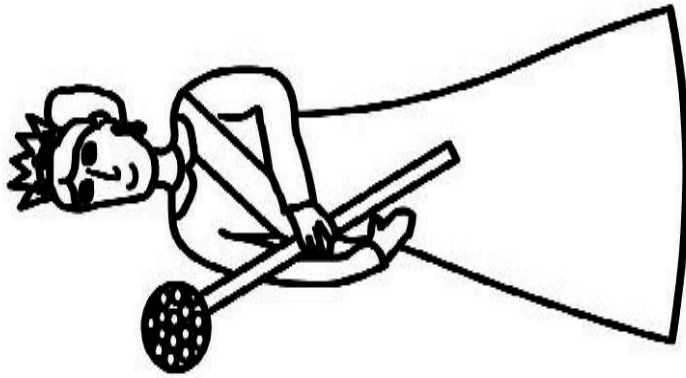

R

r

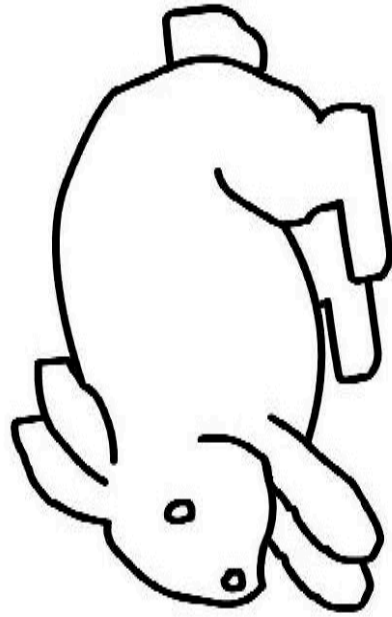

S s

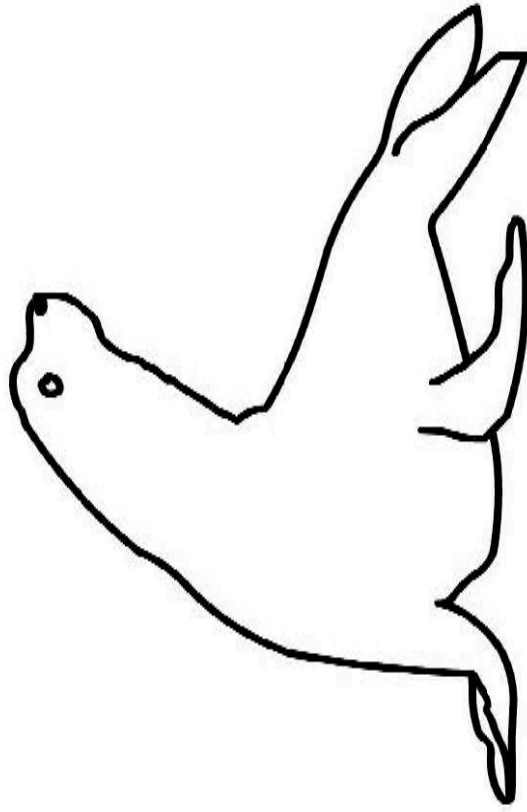

T t

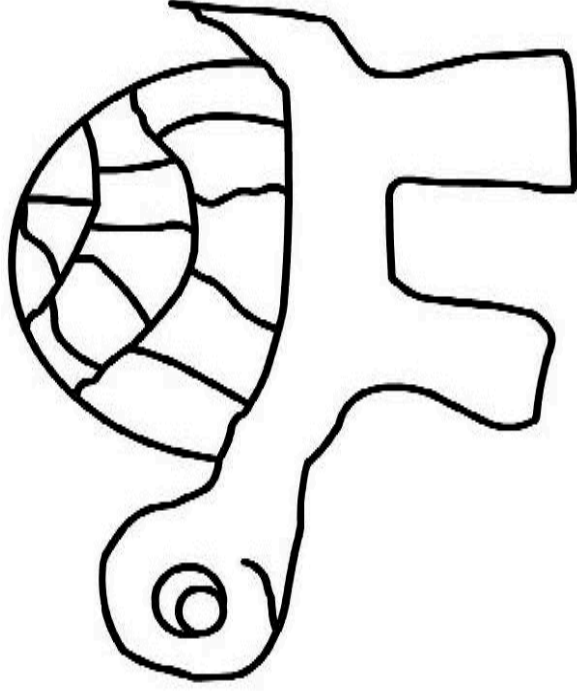

U u

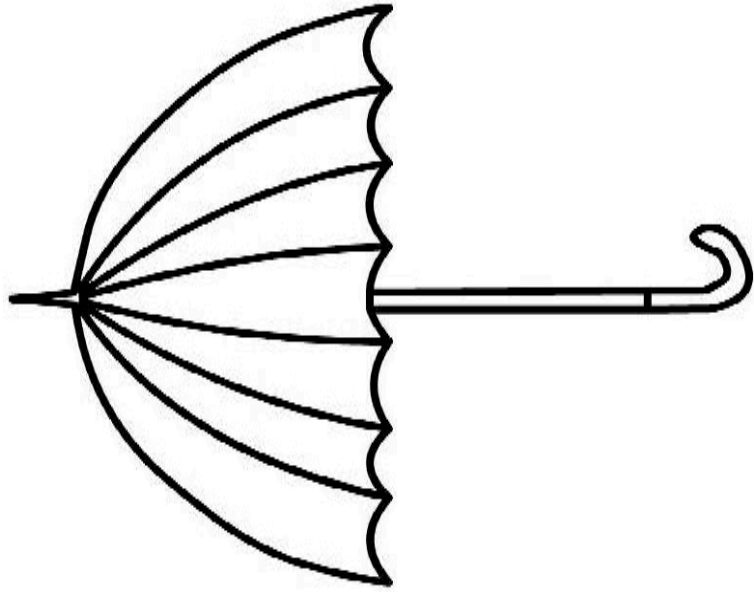

V v

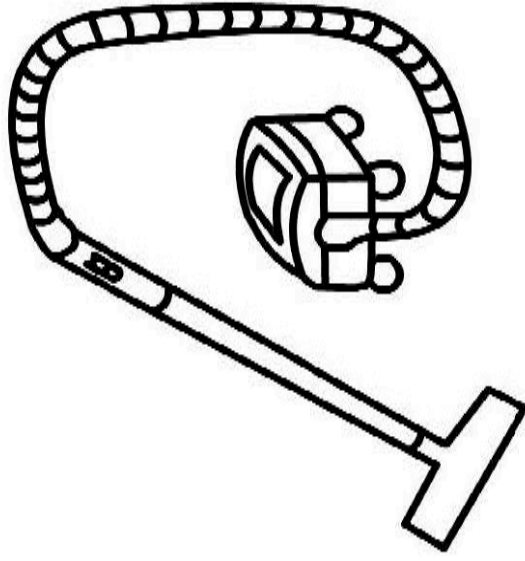

W w

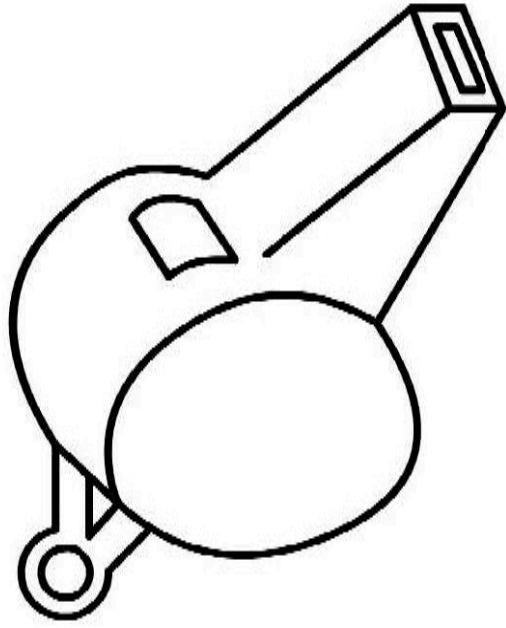

X x

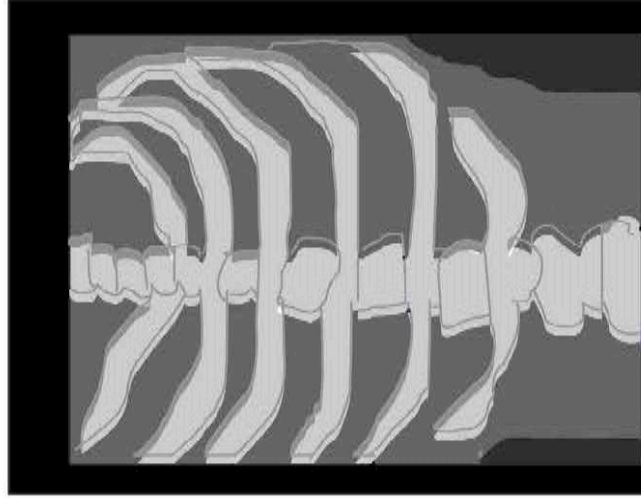

*Chest X ray 22.4.08*

Y

y

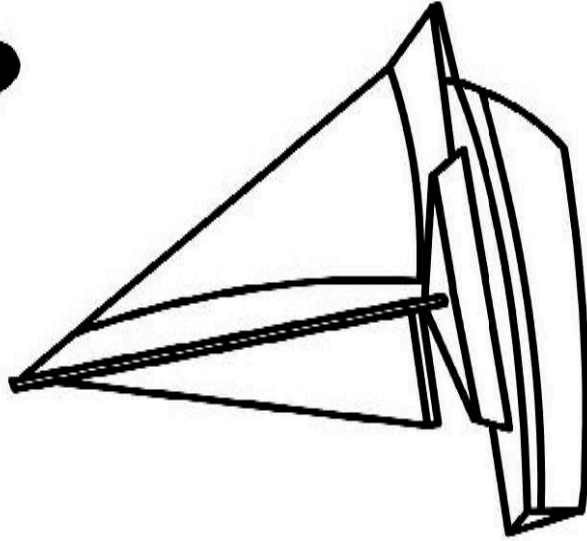

Z

z

